

## STRANGE ACTIONS OF GROUPS ON SPHERES

MICHAEL H. FREEDMAN & RICHARD SKORA

A theme in topology is that certain group actions may be made geometric by a change of coordinates. In this paper geometric means conformal. In the mid 1970's F. Gehring and B. Palka expressed hope that a uniformly quasiconformal action  $G \times S^n \rightarrow S^n$  is conjugate by a quasiconformal homeomorphism to a conformal action [11]. This was proved to be true by D. Sullivan [20] and P. Tukia [21] when  $n = 2$ .

Let  $F_r$  denote a free group of rank  $r$  and  $F_r \rtimes \mathbf{Z}_{2r}$  a certain semidirect product (defined precisely later). One of our two main results is (see §3): For  $r$  sufficiently large<sup>1</sup> there is a discrete, smooth, uniformly quasiconformal action  $\psi: (F_r \rtimes \mathbf{Z}_{2r}) \times S^2 \rightarrow S^3$  which is not conjugate (by any homeomorphism) to a conformal action.

There has been interesting earlier work in this direction. Tukia [22] for  $n > 2$  constructed a uniformly quasiconformal action  $G \times S^n \rightarrow S^n$  of a connected solvable Lie group  $G$ , where  $G$  does not embed in the Möbius group of  $S^n$ . Our example differs from Tukia's in that our action is discrete and smooth ( $= C^\infty$ ). Recently, G. Martin [15] has constructed a discrete (but not smooth), uniformly quasiconformal action on  $S^n$ ,  $n \geq 3$ , which is not quasiconformally conjugate to a conformal action but is topologically conjugate to a conformal action.

The failure of the higher dimensional Smith conjecture is relevant. It was long known to topologists that for each  $n \geq 4$  there are smooth, finite cyclic actions on  $S^n$  whose fixed point sets are nontrivially knotted  $(n - 2)$ -spheres [12]. These, of course, could not be topologically conjugate to elliptic (conformal) groups which after a further conjugation are linear. In fact, the action  $\psi$

---

Received June, 1986. The first author was supported in part by National Science Foundation Grant DMS83-03126, and a MacArthur Foundation Award.

<sup>1</sup>The minimal  $r$  suitable in our constructions seems to be more than ten and less than 100.

can be thought of as a counterexample to a natural three-dimensional generalization of the Smith conjecture where the compactness of the group is replaced by the compactness condition: uniform quasiconformality.

At the other extreme, we produce, for any  $r \geq 2$ , an action  $\phi$  of  $F_r$  on  $S^3$  which is continuous but is not topologically conjugate to any group of uniformly quasiconformal transformations. What is novel here is that each element of  $F_r$  is *individually* conjugate to a conformal (actually hyperbolic) transformation; so that the wildness arises from interplay of the generators, not the dynamics of any one singly.

Our examples are drawn from a class we call *admissible actions* (defined below). Within this class are Schottky groups,  $\phi$ , and  $\psi$  which respect the conformal structure to varying degrees. Like Schottky actions, admissible actions have limit sets homeomorphic to Cantor sets. The embedding of this Cantor set in  $S^n$  is key to our investigation.

Cantor sets imbedded in  $S^n$  are of two types. A Cantor set  $\mathcal{C} \subset S^n$  is *tame* if there is a homeomorphism  $h: S^n \rightarrow S^n$  such that  $h(\mathcal{C})$  lies on a smoothly embedded arc; otherwise,  $\mathcal{C}$  is *wild*. It is well known that a Cantor set  $\mathcal{C} \subset S^n$  is tame if and only if for all  $\varepsilon > 0$  there are disjoint  $n$ -balls  $B_1, \dots, B_k \subset S^n$  such that each is of diameter less than  $\varepsilon$  and  $\mathcal{C} \subset \bigcup B_k$ . Hence, the Schottky actions have tame Cantor set limit sets.

Both  $\phi$  and  $\psi$  have wild Cantor set limit sets. It is an attractive idea that purely topological properties of a Cantor limit set would be obstructions to the action being compatible with various structures (e.g., conformal, uniformly quasiconformal,  $C^n$ , Lipschitz, and Hölder). However, contrary to an earlier conjecture of ours, Bestvina and Cooper ([1] and [2]) have devised conformal actions on  $S^3$  whose limit set is a wild Cantor set. Thus any constraint that the topology of  $\Lambda$  imposes on the compatible structures is subtle.

In §1 we review the Schottky group, define admissible action, and recall the definition of a uniformly quasiconformal action. The action  $\phi$  is constructed in §2, and it is proved that  $\phi$  is not conjugate to a uniformly quasiconformal action. The action  $\psi$  is constructed in §3, and it is shown that  $\psi$  is smooth and uniformly quasiconformal but not conjugate to a conformal action. In an earlier paper [10] the first author showed that extension from  $S^3$  to  $S^4$  of admissible actions by free groups is equivalent to the topological surgery conjecture. With this background in mind we consider the extension question for  $\phi$  and  $\psi$ . In §4 it is shown that both  $\phi$  and  $\psi$  extend to admissible actions on  $S^4$ . We also give an example of an admissible action (by a nonfree group) which does not have an extension. In §5 we describe two techniques which yield admissible actions in higher dimensions. We also show that these actions extend to admissible actions on the next higher dimensional sphere.

### 1. Background

In this paper we will be comparing group actions which may be topological or smooth with a standard conformal model. The reader should not presume unstated structure to maps or actions beyond continuity. Given an action  $\alpha: G \times S^n \rightarrow S^n$ , the collection of points of  $S^n$ , which have neighborhoods  $\mathcal{N}$  such that all but finitely many translates of  $\mathcal{N}$  under the action are disjoint with  $\mathcal{N}$ , is called the *domain of discontinuity* of  $\alpha$ , denoted  $\Omega_\alpha$ . The *limit set* of  $\alpha$  is  $S^n - \Omega_\alpha$ , denoted  $\Lambda_\alpha$ . An action is *properly discontinuous* if every compactum meets only finitely many of its translates.

Our examples are modelled on the Schottky groups, familiar from geometric function theory. Choose a collection  $\{A_1, B_1, \dots, A_r, B_r\}$  of disjoint, round  $n$ -balls in  $S^n$ . Then there are (nonunique) conformal maps  $j_1, \dots, j_r: S^n \rightarrow S^n$  such that  $j_i(S^n - \dot{A}_i) = B_i$ . The group generated by the  $j_i$ 's under composition is by definition a *Schottky group*.<sup>2</sup>

Let  $\mathcal{D} = S^n - \dot{A}_1 - \dot{B}_1 - \dots - \dot{A}_r - \dot{B}_r$ . Then the group graph of the free group of rank  $r$ , denoted  $F_r$ , is dual to the collection of translates of  $\mathcal{D}$  under the Schottky group. Thus the Schottky group is isomorphic to  $F_r$ . Denote the action by  $\omega: F_r \times S^n \rightarrow S^n$ . It is well known that  $\omega$  is properly discontinuous on  $\Omega_\omega$ , and  $\Lambda_\omega$  is a tame Cantor set.

**1.1. Definition.** Let  $G$  be a finite generated group and  $G \times S^n \rightarrow S^n$  an action. Then  $\alpha$  is *admissible* if: (1)  $\alpha$  is properly discontinuous on  $\Omega_\alpha$ , (2)  $\Omega_\alpha/\alpha$  is compact, and (3)  $\Lambda_\alpha$  is a Cantor set.

Admissible actions where  $G$  is a free group arise naturally in the study of the topological surgery problem. The exact connection is described by Freedman [10].

Up to (topological) conjugation two Schottky actions of the same rank are equivalent. Below we prove a much stronger result which is needed in §§4 and 5. The main tool is the Stable Homeomorphism Theorem which was proved in dimension 2 by T. Radó [18], dimension 3 by E. Moise [16], dimension 4 by F. Quinn [17], and dimension  $\geq 5$  by R. Kirby [13]. Two well-known implications are the Annulus Theorem and that any orientation preserving homeomorphism of the  $n$ -sphere to itself is isotopic to the identity.

Let  $a_1, b_1, \dots, a_r, b_r$  be disjoint topologically flat  $n$ -balls in  $S^n$ ,  $n \geq 2$ , and  $g_1, \dots, g_r: S^n \rightarrow S^n$  orientation preserving homeomorphisms, such that  $g_i(S^n - \dot{a}_i) = b_i$ ,  $i = 1, \dots, r$ , and the corresponding action  $\mu$  is admissible. Similarly let  $c_1, d_1, \dots, c_r, d_r$  be disjoint topologically flat  $n$ -balls and  $h_1, \dots, h_r$

---

<sup>2</sup>There are slightly more general definitions of Schottky group; for example see [14].

orientation preserving homeomorphisms, such that  $h_i(S^n - \dot{c}_i) = d_i$ ,  $i = 1, \dots, r$ , and the corresponding action  $\nu$  is admissible.

**1.2. Theorem.** *The actions  $\mu$  and  $\nu$  are conjugate.*

*Proof.* It suffices to find a homeomorphism  $k: S^n \rightarrow S^n$ , such that  $k \circ g_i \circ k^{-1} = h_i$ ,  $i = 1, \dots, r$ . Repeated applications of the Annulus Theorem gives an orientation preserving homeomorphism

$$k: S^n - \dot{a}_1 - \dot{b}_1 - \dots - \dot{a}_r - \dot{b}_r \rightarrow S^n - \dot{c}_1 - \dot{d}_1 - \dots - \dot{c}_r - \dot{d}_r,$$

such that  $k(\partial a_i) = \partial c_i$  and  $k(\partial b_i) = \partial d_i$ ,  $i = 1, \dots, r$ . Since  $k \circ g_i \circ k^{-1}|_{\partial c_i}$  is isotopic to  $h_i|_{\partial c_i}$ , we may assume that (after isotopy)  $k \circ g_i \circ k^{-1}|_{\partial c_i} = h_i|_{\partial c_i}$ ,  $i = 1, \dots, r$ . Now  $k$  extends equivariantly to all of  $S^n$  and the proof is completed. q.e.d.

The following account of modulus may be read in more detail in [23]. A *path* in a topological space  $X$  is a map  $\gamma: [0, 1] \rightarrow X$  and a *path family* in  $X$  is a nonempty collection of paths in  $X$ . If  $\Gamma$  is a path family in  $S^3$ , then  $F(\Gamma)$  denotes the set of all Borel measurable functions  $\rho: S^3 \rightarrow [0, +\infty]$  such that

$$\int_{\gamma} \rho ds \geq 1$$

for all rectifiable  $\gamma \in \Gamma$ . The *modulus* of  $\Gamma$ , denoted  $M(\Gamma)$ , is

$$\inf_{\rho \in F(\Gamma)} \int_{S^3} \rho^3 dm.$$

Given open sets  $U, V \subset S^3$  and a homeomorphism  $f: U \rightarrow V$ , the *dilatation* of  $f$ , denoted  $K(f)$ , is the maximum of

$$\sup_{\Gamma} \frac{M(\Gamma)}{M(f(\Gamma))} \quad \text{and} \quad \sup_{\Gamma} \frac{M(f(\Gamma))}{M(\Gamma)},$$

where  $\Gamma$  ranges over all path families in  $U$  such that  $M(\Gamma)$  and  $M(f(\Gamma))$  are not simultaneously 0 nor simultaneously  $+\infty$ . Given any  $x \in U$  the *dilatation of  $f$  near  $x$* , denoted  $K(f, x)$ , is  $\inf_N K(f|N)$ , where  $N$  ranges over all open neighborhoods of  $x$  in  $U$ . It is well known that  $K(f) = \sup_{x \in U} K(f, x)$ . Also  $f$  is conformal if and only if  $K(f) = 1$ .

The homeomorphism  $f$  is *K-quasiconformal* if  $K(f) \leq K < +\infty$ . An action  $G \times S^3 \rightarrow S^3$  is *K-quasiconformal* if  $K(f) \leq K < +\infty$  for all  $f \in G$ . A *K-quasiconformal action* is also called *uniformly quasiconformal*.

## 2. The example $\phi$

In this section we begin to show the diversity of admissible actions by constructing an admissible action  $\phi: F_2 \times S^3 \rightarrow S^3$  which is not conjugate to a uniformly quasiconformal action. In particular,  $\phi$  is not conjugate to a conformal action.

Let  $a_1, a_2, b_1, b_2$  be disjoint, locally flat, solid tori in  $S^3$  as pictured in Figure 2.1. Since each torus is unknotted, there are orientation-preserving homeomorphisms  $j_1, j_2: S^3 \rightarrow S^3$  such that  $j_1(S^3 - \dot{a}_1) = b_1$  and  $j_2(S^3 - \dot{a}_2) = b_2$ . The image of  $j_1$  is pictured in Figure 2.2. The group generated by  $j_1, j_2$  under composition is the free group of rank 2, denoted  $F_2$ .

Let  $\mathcal{D} = S^3 - \dot{a}_1 - \dot{a}_2 - \dot{b}_1 - \dot{b}_2$  and  $U = \cup F_2(\mathcal{D})$  (we do not claim that  $U$  is the set of discontinuity nor that  $S^3 - U$  is a Cantor set). The topology of  $S^3 - U$  depends on the choices of  $j_1$  and  $j_2$ . We next show how to choose  $j_1$  and  $j_2$  to ensure  $S^3 - U$  is a Cantor set.

First, it is necessary to review a result of Decomposition Space Theory. Let  $T_0, T_1$  be locally flat solid tori embedded in a third solid torus  $T \subset S^3$  as shown in Figure 2.3. For any solid torus  $L \subset S^3$  define  $\text{Bing}(L)$  to be  $\{h(T_0), h(T_1)\}$ , where  $h: T \rightarrow L$  is any homeomorphism taking a longitude of

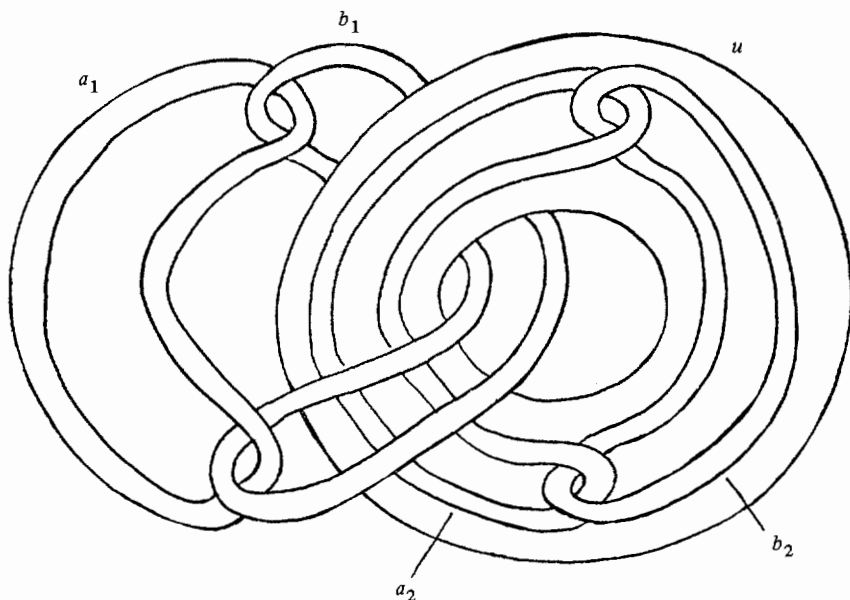

FIGURE 2.1

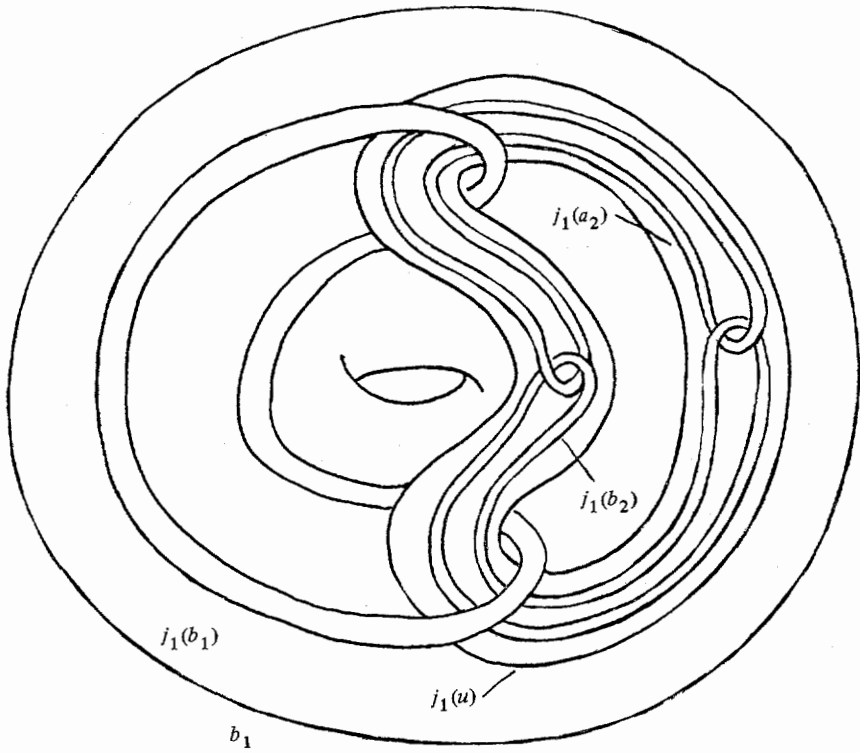

FIGURE 2.2

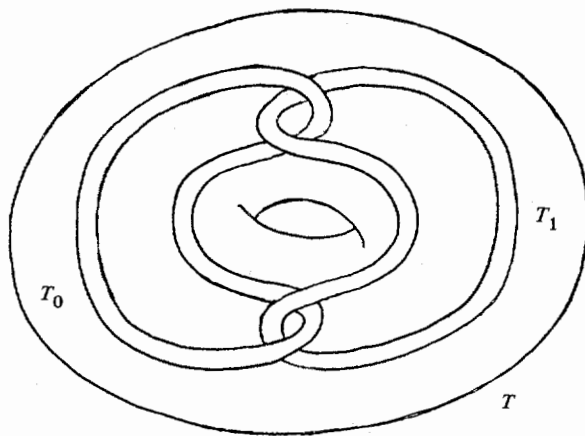

FIGURE 2.3

$T$  to a longitude of  $L$  (so  $\text{Bing}(L)$  is unique up to isotopy relative  $\partial T$ ). More generally, for any union  $L = T_1 \cup \dots \cup T_n$  of disjoint solid tori in  $S^3$  define  $\text{Bing}(L) = \cup \text{Bing}(T_i)$ , and  $\text{Bing}^k(L)$  to be the  $k$ th iterate. Then it is an amazing result of R. H. Bing that there is a sequence  $L = L_0, L_1, L_2, \dots$  such that  $L_k = \text{Bing}(L_{k-1})$  and the diameters of the elements of  $L_k$  go to zero as  $k$  goes to  $+\infty$  (this is far from trivial—try it, then consult [3], [4]). Since a Cantor set is characterized as a compact, zero dimensional metric space without isolated points, one also has  $\bigcap_k \cup L_k$  is a Cantor set.

Bing’s result applies to our problem in the following way. The set  $U$  is determined by  $j_1, j_2$ . But conversely, certain reembeddings of  $U$  into  $S^3$  determine allowable choices for  $j_1, j_2$ . Bing’s result implies that  $U$  may be isotoped in  $S^3$  such that  $S^3 - U$  is a Cantor set. Such an embedding does indeed permit allowable choices for  $j_1, j_2$ . Therefore suppose  $j_1, j_2$  were chosen such that  $S^3 - U$  is a Cantor set. Let the action be denoted  $\phi: F_2 \times S^3 \rightarrow S^3$ . Clearly  $\Omega_\phi = U$  and the action is admissible.

**2.1. Theorem.** *The action  $\phi: F_2 \times D^3 \rightarrow D^3$  is admissible and not conjugate to a uniformly quasiconformal action.*

Before proceeding with the proof, notice that Theorem 2.1 implies that  $\phi$  is quite strange. Each element of  $F_2$ , however, is conjugate to a hyperbolic element of the Möbius group. Furthermore,  $F_2$  contains subgroups of arbitrarily large rank which are conjugate to Schottky groups. For example,  $j_1$  and  $(j_2)^2$  generate a subgroup conjugate to a Schottky group.

Similar actions of larger groups  $F_r, r > 2$ , may easily be constructed. One such construction is to take the restriction of  $\phi$  to any subgroup of  $F_2$  of finite index.

Let  $T$  be a (topological) solid torus such that  $\hat{T}$  is equipped with a fixed Riemannian metric. Let  $\Gamma_T$  denote the set of all closed paths  $\gamma: [0, 1] \rightarrow \hat{T}$  which represent generators for  $\pi_1(\Gamma)$ . Then the length of  $T$  is

$$\inf_{\gamma \in \Gamma_T} \int_{\gamma} ds.$$

The following is a pleasing counterpoint to Bing’s shrinking argument: The diameters of the components of  $\text{Bing}^k(T)$  may be arranged to approach zero, but the lengths are more recalcitrant and some stay bounded from below.

**2.2. Lemma.** *Let  $T \subset S^3$  be a locally flat, solid torus (with the inherited Riemannian metric on  $\hat{T}$ ). There exists  $c > 0$ , such that*

$$c \leq \frac{1}{2^k} \sum_{V \in \text{Bing}^k(T)} \text{length}(V)$$

for all  $k$ . In particular,  $c \leq \text{length}(V)$  for some  $V \in \text{Bing}^k(T)$ .

We need the following.

**2.3. Lemma.** *Let  $S^1$  be the unit circle,  $D^2$  the unit disk, and  $S^1 \times D^2$  the smooth solid torus with the product Riemannian metric. Then*

$$2\pi \leq \frac{1}{2^k} \sum_{V \in \text{Bing}^k(S^1 \times D^2)} \text{length}(V)$$

for all  $k$ .

**2.4. Lemma.** *Fix  $k$ , and for each  $V \in \text{Bing}^k(S^1 \times D^2)$  choose  $\gamma_V \in \Gamma_V$ . If  $\Delta$  is any smooth, properly embedded, nonseparating disk in  $S^1 \times D^2$ , then  $\Delta \cap \bigcup_V \gamma_V [0, 1]$  contains at least  $2^k$  points.*

**2.5. Lemma.** *Let  $(P, \partial) \subset (S^1 \times D^2; \partial)$  be an embedded connected planar surface representing the generator of  $H_2(S^1 \times D^2, \partial; \mathbf{Z})$ . Let  $T_1$  and  $T_2$  be solid tori embedded in  $S^1 \times D^2$  as a Bing double. Suppose  $P$  and  $T_1 \cup T_2$  meet in transverse general positions. Then for  $i = 1$  or  $2$ ,  $P \cap T_i$  must contain at least two surfaces which represent generators of  $H_2(T_i, \partial; \mathbf{Z})$ .*

*Proof.* For homological reasons  $[P \cap T_i, \partial] = 0 \in H_2(T_i, \partial; \mathbf{Z})$ . If every component of  $P \cap T_i$  is homologically trivial in  $T_i$ , then an elementary argument replaces  $P$  with a new compact planar surface  $Q \subset S^1 \times D^2$ ,  $\partial Q = \partial P$ , and with  $Q \cap (T_1 \cup T_2) = \emptyset$ . [Construction of  $Q$ : Make  $P$  transverse to  $T_1 \cup T_2$ . Beginning with innermost circle, do embedded surgery along those circles of intersection which are trivial in  $T_1 \cup T_2$ . Discard 2-sphere components. The intersections with  $T_1 \cup T_2$  now consist of embedded annuli. Again, beginning with innermost annuli replace these embedding with copies of annuli lying in the boundary  $\partial(T_1 \cup T_2)$ .] This is certainly impossible, and to obtain the contradiction lift  $Q$  to a surface  $\tilde{Q}$  in the universal cover  $R^1 \times D^2 \xrightarrow{\pi} S^1 \times D^2$ . The inverse image,  $\pi^{-1}(\text{Core } T_1 \cup \text{Core } T_2)$  is an infinite chain in which consecutive links have linking number one. Since  $Q$  generates  $H_2(R^1 \times D^2)$ ,  $\tilde{Q}$  separates, so some consecutive pair of links  $\gamma$  and  $\gamma'$  must lie on opposite sides of  $\tilde{Q}$ . Now slide these circles along  $\partial(R^1 \times D^2)$  toward  $+\infty$  and cap them off far away from  $\gamma'$ . This constructs new null homology for  $\gamma$  which is disjoint from  $\gamma'$  contradicting the fact that  $\gamma$  and  $\gamma'$  have linking number one. q.e.d.

*Proof of 2.4.* By general position suppose the boundaries of the  $V$ 's are transverse to  $\Delta$  and the  $\gamma_V$ 's still lie in their interiors. Applying Lemma 2.5  $k$  times, we see that  $\Delta \cap \bigcup \text{Bing}^k(S^1 \times D^2)$  contains at least  $2^k$  disjoint planar surfaces which each represent a generator of  $H_2(\bigcup \text{Bing}^k(S^1 \times D^2), \partial; \mathbf{Z})$ . By duality,  $\Delta \cap \bigcup_V \gamma_V [0, 1]$  contains at least  $2^k$  points. q.e.d.

Given a smooth path:  $f [0, 1] \rightarrow S^1$ , let  $\#_f: S^1 \rightarrow \{0, 1, 2, \dots, +\infty\}$  be the function which assigns to each  $y \in S^1$  the number of points in  $f^{-1}(y)$ . Then the following is easy and the proof is left to the reader.



**2.6. Lemma.** *The function  $\#_f$  is measurable and  $\int_{S^1} \#_f dm = \text{length}(f)$ .*

*Proof of 2.3.* Fix  $k$ . For each  $V \in \text{Bing}^k(S^1 \times D^2)$  choose a smooth loop  $\gamma_V \in \Gamma_V$ . Let  $p: S^1 \times D^2 \rightarrow S^1$  be the projection. By Lemma 2.4,

$$2\pi \leq \frac{1}{2^k} \sum_V \int_{S^1} \#_{p \circ \gamma_V} dm.$$

By Lemma 2.6

$$\int_{S^1} \#_{p \circ \gamma_V} dm = \text{length}(p \circ \gamma_V),$$

and because  $S^1 \times D^2$  has the product metric  $\text{length}(p \circ \gamma_V) \leq \text{length}(\gamma_V)$ . Combining inequalities we have

$$2\pi \leq \frac{1}{2^k} \sum_V \text{length}(\gamma_V).$$

Since  $\text{length}(V)$  is the infimum of  $\text{length}(\gamma_V)$  over all smooth  $\gamma_V$ 's, the proof is complete.

*Proof of 2.2.* Since  $T$  is locally flat, the 3-dimensional Hauptvermutung implies  $T$  is approximated by a smooth embedding  $f: S^1 \times D^2 \rightarrow S^3$ , such that  $f(S^1 \times D^2) \supset T$ . Since  $S^1 \times D^2$  is compact there is a constant  $s > 0$  such that  $s\|v\| \leq \|Df(v)\|$  for all  $v$  in the tangent space of  $S^1 \times D^2$ . Take  $c = 2\pi s$  and the result follows from Lemma 2.3. q.e.d.

Let  $T \subset S^3$  be a solid torus. The volume of  $T$  is  $\int_T dm$ .

**2.7. Lemma.** *If  $T \subset S^3$  is a locally flat, solid torus (with the inherited Riemannian metric on  $\hat{T}$ ), then*

$$0 < M(\Gamma_T) \leq \text{volume}(T) \left( \frac{1}{\text{length}(T)} \right)^3.$$

*Proof.* For the left inequality consider a smooth embedding  $f: S^1 \times D^2 \rightarrow \hat{T}$  such that inclusion is a homotopy equivalence. It is well known that  $0 < M(\Gamma_{f(S^1 \times D^2)})$ , and by definition  $M(\Gamma_{f(S^1 \times D^2)}) \leq M(\Gamma_T)$ .

We now prove the right inequality. It is easy to see that  $0 < \text{length}(T)$ . Define the Borel measurable function  $\rho: S^3 \rightarrow [0, +\infty]$  as

$$\rho(x) = \begin{cases} 1/\text{length}(T), & x \in T; \\ 0, & x \notin T. \end{cases}$$

Clearly,  $\rho \in F(\Gamma_T)$ . Hence

$$M(\Gamma_T) \leq \int_{S^3} \rho^3 dm = \text{volume}(T) \left( \frac{1}{\text{length}(T)} \right)^3. \quad \text{q.e.d.}$$

*Proof of 2.1.* Since  $\phi$  is well defined only up to conjugation, it suffices to show  $\phi$  is not uniformly quasiformal. We would like to use Lemma 2.2 to claim something about the lengths of translates of  $a_1, a_2, b_1, b_2$  under  $F_2$ . Due to the lopsidedness of Figure 2.2, however, we need to introduce auxiliary tori. Let  $u \subset S^3$  be the solid torus pictured in Figure 2.1. Its image under  $j_1$  is shown in Figure 2.2. Notice that  $\text{Bing}(b_1) = \{j_1(b_1), j_1(u)\}$ . Let  $v = S^3 - \hat{u}$ ; then  $v$  has properties similar to  $u$ .

Let  $F_2\{a_1, a_2, b_1, b_2, u, v\}$  be the collection of images of the six tori under all elements of  $F_2$ . Then the collection has a sequence of subsets  $L_0, L_1, \dots$  such that  $b_1 = L_0$  and  $L_k = \text{Bing}(L_{k-1})$ . By Lemma 2.2 there is a constant  $c$  and a sequence  $\{\tau_1, \tau_2, \dots\}$  of solid tori such that  $\tau_k$  belongs to  $L_k$  and  $\text{length}(\tau_k) \geq c$  for all  $k$ . Since  $\text{volume}(\tau_k) \rightarrow 0$ , Lemma 2.7 implies that  $M(\Gamma_{\tau_k}) \rightarrow 0$  as  $k \rightarrow +\infty$ .

Lemma 2.7 also implies that  $M(\Gamma_\tau) > 0$  for all  $\tau \in \{a_1, a_2, b_1, b_2, u, v\}$ . Since by construction each  $\tau_k$  is the image of some  $\tau \in \{a_1, a_2, b_1, b_2, u, v\}$  under  $F_2$ , the action is not uniformly quasiconformal. *q.e.d.*

The above proof uses that  $\text{volume}(V_k) \rightarrow 0$  as  $k \rightarrow \infty$  which follows from  $S^3 - U$  being a Cantor set. But even if  $j_1$  and  $j_2$  are chosen so that  $S^3 - U$  is not a Cantor set, the action still cannot be uniformly quasiconformal. For, suppose the action were uniformly quasiconformal then a positive lower bound on  $M(\Gamma_\tau)$  for all  $\tau \in \{a_1, a_2, b_1, b_2, u, v\}$  gives a positive lower bound  $b$  on  $M(\Gamma_V)$  for all  $V \in \cup_k L_k$ . By Lemma 2.7,  $\text{length}^3(V) \leq \text{volume}(V)/b$ . The Hölder inequality gives

$$\begin{aligned} \sum_{V \in L_k} \text{length}(V) &\leq \left( \sum_{V \in L_k} \text{length}^3(V) \right)^{1/3} \left( \sum_{V \in L_k} 1 \right)^{2/3} \\ &\leq \left( \frac{\text{volume}(S^3)}{b} \right)^{1/3} (2^k)^{2/3}. \end{aligned}$$

But this contradicts Lemma 2.2 which says that  $\sum_{V \in L_k} \text{length}(V)$  grows like  $2^k$ .

It should also be remarked that any explicit shrinking argument for the Bing decomposition gives new coordinates to  $S^3$  by which  $\phi$  can be measured. In principle, one can estimate the quality of the continuity of  $\phi$ , i.e., how large can  $\delta$  be and still  $\epsilon$ -control the value of  $f \in F_2$ . Bing's original shrinking argument (1952) [3] is surpassed in efficiency by a recent argument [4]. A careful look at Bing's new shrinking argument shows that for every  $f \in F_2$  there is a  $c > 0$  (in fact,  $c$  may be taken proportional to the word length of  $f$ ) such that for all  $\epsilon > 0$  there is  $\delta > e^{-c/\epsilon} > 0$  such that  $\text{dist}_{S^3}(S_0, S_1) < \delta$

implies  $\text{dist}_{S^3}(f(S_0), f(S_1)) < \varepsilon$ . This condition is somewhat weaker, for example, than Hölder continuity. A still weaker condition results from the 1952-shrink.

### 3. The example $\psi$

In this section we construct an admissible action  $\psi: (F_r \times \mathbf{Z}_{2r}) \times S^3 \rightarrow S^3$ ,  $3 \leq r$ . We show that for  $r$  sufficiently large, each  $\psi$  is smooth and uniformly quasiconformal but not conjugate to a conformal action. The construction of  $\psi$  will be given in stages; hypotheses will be added as needed.

Let  $a_1, a_2, \dots, a_r, b_1, b_2, \dots, b_r$ ,  $3 \leq r$ , be pairwise disjoint, locally flat solid tori in  $S^3$ ; their image after stereographic projection  $s: S^3 - \{\infty\} \rightarrow \mathbf{R}^3$  is shown in Figure 3.1. Since the solid tori are individually unknotted, there are homeomorphisms  $h_i: S^3 \rightarrow S^3$  such that  $h_i(S^3 - \hat{a}_i) = b_i$ ,  $i = 1, 2, \dots, r$ . When  $r = 3$ ; the image of a typical  $h_i$  is shown in Figure 3.2. The image of  $h_i^{-1}$  is similar. The  $h_i$ 's generate the free group of rank  $r$ , denoted  $F_r$ .

Take  $\mathcal{D} = S^3 - \hat{a}_1 - \dots - \hat{a}_r - \hat{b}_1 - \dots - \hat{b}_r$  and  $U = \cup F_r(\mathcal{D})$ . The embedding of  $U$  in  $S^3$  depends on the choices of the  $h_i$ 's. As in §2, we will show that the  $h_i$ 's may be chosen such that  $S^3 - U$  is a Cantor set. This time, however, we need not appeal to Decomposition Space Theory. The reason is contained in Figure 3.2. The tori in  $b_1$  may easily be isotoped to each have diameter smaller than the diameter of  $b_1$  (in the worst case,  $r = 3$ , each torus in  $b_1$  has length about  $4/5$  that of  $b_1$ ). Thus  $U$  may be isotoped such that the diameter of  $f(\mathcal{D})$  goes to zero as the word length of  $F_r$  goes to  $+\infty$ . This new embedding of  $U$  guarantees that  $S^3 - U$  is a Cantor set and determines  $h_i$ 's with the desired property. Let the action be denoted  $\psi_0: F_r \times S^3 \rightarrow S^3$ .

Next we show that for  $r$  large,  $\psi_0$  acts smoothly and uniformly quasiconformally. The solid tori  $a_1, \dots, b_1, \dots$  should be thought of as rigid—not changing shape nor size. Imagine that they make up the links of a necklace which grows more flexible as the number of links increases. Figure 3.3 gives a new picture of  $h_1$  after stereographic projections. It is clear from the figure that we may add the hypothesis that for  $r$  sufficiently large,  $s \circ h_i \circ s^{-1}$  restricted to a neighborhood of each of  $s(a_1), \dots, s(\overline{a_i}), \dots, s(b_r)$  is a similarity transformation. Similarly hypothesize that  $s \circ h_i^{-1} \circ s^{-1}$  restricted to a neighborhood of each of  $s(a_1), \dots, s(\overline{b_i}), \dots, s(b_r)$  is a similarity transformation. In particular,  $h_i$  restricted to a neighborhood of  $a_1, \dots, \hat{a}_i, \dots, b_r, h_i^{-1}(a_1), \dots, h_i^{-1}(b_i), \dots, h_i^{-1}(b_r)$  is conformal. Finally we also hypothesize that  $h_i$  is smooth. It should be mentioned that the new hypotheses do not conflict with the assumption that  $S^3 - U$  is a Cantor set. In fact, the

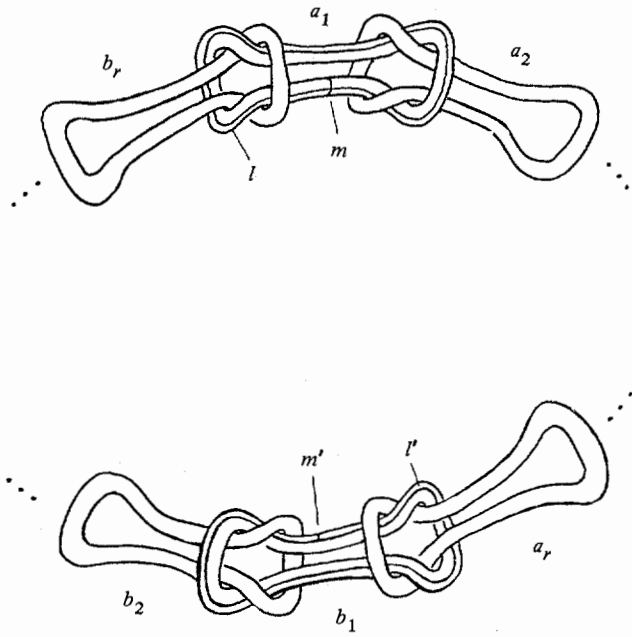

FIGURE 3.1

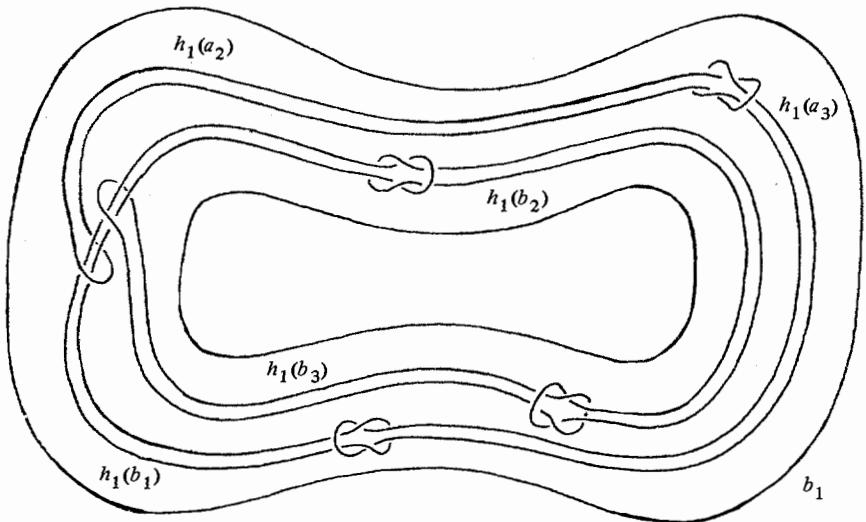

FIGURE 3.2

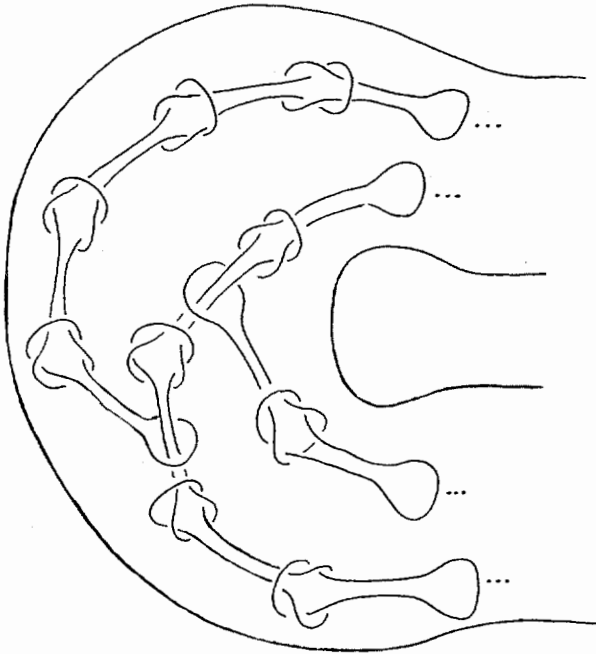

FIGURE 3.3

construction now guarantees that  $S^3 - U$  is a Cantor set: the diameter of  $f(\mathcal{D})$  decreases geometrically as the word length of  $f$  goes to  $\infty$ .

Since the  $h_i$ 's are smooth,  $\psi_0$  acts smoothly, and for some  $K < +\infty$  each  $h_i$  is  $K$ -quasiconformal. To show  $F_r$  acts uniformly quasiconformally we use crucially that each  $h_i$  is conformal in a neighborhood of  $\Lambda_{\psi_0}$ , hence, dilatation does not build up under composition.

We claim that  $f$  is  $K^2$ -quasiconformal for all  $f \in F_r$ . It suffices to show that the dilatation of  $f$  near each  $x \in S^3$  is no greater than  $K^2$ . Let  $f = f_m \circ \dots \circ f_1$ ,  $f_i \in \{h_i^{\pm 1}, \dots, h_r^{\pm 1}\}$ , be a reduced word, and let  $x_i$  be defined inductively by  $x_1 = x$ ,  $x_{i+1} = f_i(x_i)$ . Then the dilatation of  $f$  near  $x$  is no greater than the product of dilatations of each  $f_i$  near  $x_i$ . If  $x_i \notin \mathcal{D} \cup f_i^{-1}(\mathcal{D})$ , then the dilatation of  $f_i$  near  $x_i$  is 1, otherwise the dilatation is less than or equal to  $K$ . The structure of the free group implies that  $x_i \in \mathcal{D} \cup f_i^{-1}(\mathcal{D})$  for at most two  $i$ 's. Therefore the dilatation of  $f$  near  $x$  is no greater than  $K^2$ .

Thus for  $r$  sufficiently large the action  $\psi_0$  is smooth and uniformly quasiconformal. For small values of  $r$  we doubt that  $\psi_0$  can be smooth or uniformly quasiconformal. It is also unknown whether any  $\psi_0$  is conjugate to a conformal action. We now make a final enhancement.

Recall Figure 3.1; there is a rotational symmetry. Let  $g: S^3 \rightarrow S^3$  be the conformal transformation of period  $2r$  induced by isometric rotation of  $\mathbf{R}^3$  about a line through an angle of  $\pi/r$  radians. So  $g(a_1) = a_2, \dots, g(a_r) = b_1, \dots, g(b_r) = a_1$ . We also want that  $g \circ h_1 \circ g^{-1} = h_2, \dots, g^{r-1} \circ h_1 \circ g^{1-r} = h_r$  and that  $g^r \circ h_1 \circ g^{-r} = h_1^{-1}$ . Before adding hypotheses to  $h_1$ , it is appropriate to examine  $h_1$  more closely.

In Figure 3.1 the oriented meridional and longitudinal curves of  $a_1$  (and  $b_1$ ) are respectively labeled  $m$  and  $l$  (and respectively  $m'$  and  $l'$ ). Suppose  $g^r(m) = m'$  and  $g^r(l) = l'$ . Then  $h_1|_{\partial a_1}: \partial a_1 \rightarrow \partial b_1$  is a homeomorphism such that up to homotopy  $h_1(m) = l', h_1(l) = m'$  (or  $h_1(m) = -l', h_1(l) = -m'$ , but for specificity, assume the former case). Therefore  $g^r \circ h_1|_{\partial a_1}: \partial a_1 \rightarrow \partial a_1$  is isotopic to an involution. So further suppose  $h_1$  is chosen such that  $g^r \circ h_1|_{\partial a_1}$  is an involution. Let  $h = h_1$ , then redefine  $h_1$  by

$$h_1(x) = \begin{cases} h(x), & x \in S^3 - \dot{a}_1; \\ g^r \circ h^{-1} \circ g^{-r}(x), & x \in \dot{a}_1. \end{cases}$$

Clearly  $h_1$  is continuous and  $g^r \circ h_1 \circ g^{-r} = h_1^{-1}$ . Furthermore, if care is taken in defining  $h_1$  in a neighborhood of  $\partial a_1$ , then  $h_1$  is also smooth. We omit the details.

Finally, just define  $h_2 = g \circ h_1 \circ g^{-1}, \dots, h_r = g^{r-1} \circ h_1 \circ g^{1-r}$ . Then the action of  $g$  by conjugation on the set  $\{h_1, \dots, h_r, h_1^{-1}, \dots, h_r^{-1}\}$  is cyclic permutation, and the group generated by  $h_1, g$  is a semidirect product, denoted  $F_1 \rtimes \mathbf{Z}_{2r}$ . Since  $g$  is conformal, the action by  $F_r \rtimes \mathbf{Z}_{2r}$  is smooth and uniformly quasiconformal.

Let  $\psi: (F_r \rtimes \mathbf{Z}_{2r}) \times S^3 \rightarrow S^3$  be the action. Then  $\psi$  is clearly admissible. We have:

**3.1. Theorem.** *The action  $\psi$  is admissible, and for  $r$  sufficiently large  $\psi$  is smooth and uniformly quasiconformal, but is not conjugate to a conformal action.*

*Proof.* It only remains to prove the last statement.

The group element  $g^r \circ h_1$  is an involution. It leaves invariant  $\partial a_1$  and is orientation reversing on  $\partial a_1$ . Further checking reveals that the fixed point set of  $g^r \circ h_1$  is a simple loop  $l_1 \subset \partial a_1$  (representing the diagonal homology class  $l + m \in H_1(\partial a_1; \mathbf{Z})$ ). Similarly the fixed point set of each  $g^{r+k} \circ h_1 \circ g^k$  is a simple loop  $l_{k+1}$ ,  $k = 1, \dots, 2r - 1$ . The link  $L = \{l_1, \dots, l_{2r}\}$  is isotopic to the link of longitudes of the solid tori in Figure 3.1. Standard techniques of knot theory show this to be a nontrivial link.

If  $\psi$  is conjugated by any homeomorphism  $f: S^3 \rightarrow S^3$ , the image link  $f(L)$  will be a union of fixed sets for the new action  $\psi^f$ . If  $\psi^f$  were conformal, then  $f(L)$  would be a link of round circles. Since topologically  $L$  and  $f(L)$  are

equivalent and nontrivial, the following lemma shows that  $\psi^f$  can never be conformal.

**3.2. Lemma.** *Let  $L = (l_1, \dots, l_k) \subset S^3$  be a link whose components are round circles. Then  $L$  is the trivial link if and only if the pairwise linking numbers  $\langle l_i, l_j \rangle, i \neq j$ , are all zero.*

*Proof.* Let  $S^3 = \partial B^4$ . Since each component of  $L$  is round, each component  $l_i$  bounds a unique round hemisphere  $d_i$  in  $B^4$  which meets  $S^3$  perpendicularly. By synthetic geometry, the disjointness of  $l_i$  and  $l_j, i \neq j$ , implies that  $d_i \cap d_j$  is empty or consists of exactly one point. The linking number hypothesis implies the former. The  $d_i$ 's constitute *convex* slices for the link  $L$ . Shrinking the radius of  $B^4$  evolves  $L$  to the empty link with deaths of components being the only catastrophies; this proves that  $L$  was trivial. q.e.d.

The proof of the lemma implicitly exploits the Poincaré model for  $H^4$ .

We note that the extension of  $\psi_0$  to  $\psi$  goes through for any  $r \geq 3$ . Thus  $\psi$  is not conjugate to a conformal action for any  $r \geq 3$ . Also our argument only concerns the subgroup  $F_r \rtimes Z_2 = \langle h_1, g^r \rangle$  so the theorem applies to  $\psi|_{F_r \rtimes Z_2}$ .

As was already pointed out  $\psi|_{Z_{2r} \times S^3}$  is conformal. Also each element of  $F_r$  is conjugate to a hyperbolic element of the Möbius group. Thus each element of  $F_r \rtimes Z_{2r}$  is conjugate to an element of the Möbius group. In fact for all  $i, h_1, \dots, \hat{h}_i, \dots, h_r$  generate a group which is conjugate to a Schottky group.

We point out some topological distinctions between  $\phi, \psi$ , and Schottky actions. Recall that the limit set of a Schottky action is a tame Cantor set. The complement of a tame Cantor set is simply connected. But the limit sets of both  $\phi, \psi$  are wild Cantor sets and in fact have the stronger property that their complements are not simply connected. Curiously, the limit set of  $\psi$  has the property that every proper sub-Cantor set of  $\Lambda_\psi$  has simply connected complement (see e.g. [19]). The limit set of  $\phi$  does not share this property.

Our experience suggests that for admissible actions the conditions “topologically conjugate to a smooth action” and “topologically conjugate to a uniformly quasiconformal action” will be quite difficult to distinguish by examples and may in fact be identical.

#### 4. Extensions of $\phi$ and $\psi$

In this section we show that both  $\phi$  and  $\psi$  extend to actions on  $S^4$ .

**4.1. Theorem.** *There is an invariant, topologically flat embedding  $S^3 \hookrightarrow S^4$  and Schottky action  $\omega: F_2 \times S^4 \rightarrow S^4$  such that  $\phi = \omega|_{F_2 \times S^3}: F_2 \times S^3 \rightarrow S^3$ .*

*Proof.* We first extend  $\phi$  to  $B^4$ . Identify  $S^3 = \partial B^4$ . Let  $a'_1, a'_2 \subset B^4$  be disjoint unknotted standard 2-handles with attaching regions  $a_1, a_2$  respectively. Let  $b'_1, b'_2 \subset B^4$ , such that  $(b'_i, S^3 \cap b'_i) \approx (b_i \times [0, 1], b_i \times \{0\})$ ,  $i = 1, 2$ . Then by construction  $(B^4, B^4 - \hat{a}_i) \approx (B^4, b_i)$ ,  $i = 1, 2$ .

Choose homeomorphisms  $j'_1, j'_2: B^4 \rightarrow B^4$  such that  $j'_i(B^4 - \hat{a}_i) = b'_i$  and  $j'_i|_{S^3} = j_i$ ,  $i = 1, 2$ . Let the group generated by  $j'_1, j'_2$  be denoted  $F_2$ . Define  $\mathcal{D}' = B^4 - \hat{a}'_1 - \hat{a}'_2 - \hat{b}'_1 - \hat{b}'_2$  and  $U = \cup F_2(\mathcal{D}')$ .

We claim that  $j_1, j_2$  may be chosen so that  $B^4 - U = \Lambda_\phi$ . Again it suffices to see that  $U$  may be isotoped relative  $S^3$  such that  $B^4 - U = \Omega_\phi$ . In this case it is easy and follows from the observation that  $a'_1, a'_2, b'_1, b'_2$  and their translates under  $F_2$  may be isotoped relative  $S^3$  to lie as closely as desired to  $S^3$ . Thus we choose the appropriate  $j'_1, j'_2$ .

Identify  $S^4$  with the double of  $B^4$  along  $S^3$  and let  $\phi'': F_2 \times S^4 \rightarrow S^4$  be the obvious extension of the above action. Clearly  $S^3 \rightarrow S^4$  is topologically flat. We will show that  $\phi''$  is conjugate to a Schottky action.

Let  $a''_1, b''_1, a''_2, b''_2$  be the doubles of  $a'_1, b'_1, a'_2, b'_2$  respectively resulting from doubling  $B^4$ . Both  $b''_1, b''_2$  have 1-dimensional cores; therefore, the link  $a''_1, b''_1, a''_2, b''_2$  is splittable. In particular, there are (topological) locally flat 4-balls  $A_1, A_2$  containing  $a''_1, a''_2$  respectively and each disjoint with both  $b''_1, b''_2$ . Let  $B_i = j_i(S^4 - \hat{A}_i)$ ,  $i = 1, 2$ . Clearly  $S^4 - \hat{A}_1 - \hat{A}_2 - \hat{B}_1 - \hat{B}_2$  is a fundamental domain for  $\phi''$ . By Theorem 1.2,  $\phi''$  is conjugate to a Schottky action  $\omega$ . q.e.d.

In the above theorem one may change the conclusion to have  $S^3 \rightarrow S^4$  the standard inclusion, but then  $\omega$  will only be conjugate to a Schottky action.

We now prove the analogous theorem for  $\psi$ . The argument needs to be more clever because the extension must include the cyclic symmetry.

**4.2. Theorem.** *There is an invariant, topologically flat embedding  $S^3 \hookrightarrow S^4$  and admissible action  $\psi'': (F_r \rtimes \mathbf{Z}_{2r}) \times S^4 \rightarrow S^4$  such that  $\psi = \psi''|(F_r \rtimes \mathbf{Z}_{2r}) \times S^3$ .*<sup>3</sup>

*Proof.* Again we first extend  $\psi$  to  $B^4$ . Identity  $S^3 = \partial B^4$ . Choose an unknotted topologically flat solid torus  $\tau \subset S^3$  and define  $u = \text{cone}(\tau) = \{x \in B^4 | x = \lambda x', \text{ for some } x' \in \tau \text{ and } 0 \leq \lambda \leq 1\}$ . Let  $v = B^4 - \hat{c}$ . The pair  $u, v$  have the nice property that  $(B^4, u) \approx (B^4, v)$ .

Let notation be as in §3. The homeomorphism  $g$  extends in an obvious way to a rotation  $g': B^4 \rightarrow B^4$  with fixed point set a 2-disk. Let  $p: B^4 \rightarrow B^4/g'$  be projection. The core of  $p(a_1)$  is a square knot. Hence, it bounds a 2-disk  $D$  properly embedded in  $G^4/g'$ . Furthermore,  $D$  may be chosen disjoint with the

<sup>3</sup>In another paper the authors show that  $S^3 \hookrightarrow S^4$  is standard and  $\psi''$  is smooth and uniformly quasiconformal, but not conjugate to a conformal action.



image of the fixed point set of  $g'$  such that each component of  $p^{-1}(D)$  is an unknotted disk.

Then  $D$  guides us to choose disjoint  $a'_1, \dots, a'_r, b'_1, \dots, b'_r \subset B^4$ , such that their union is invariant under  $g'$  and  $(B^4, a'_i, a_i) \approx (B^4, u, \tau) \approx (B^4, b'_i, b_i)$ . As in the proof of Theorem 3.1, there is an  $h'_1$  extending  $h_1$  and satisfying  $g^r \circ h'_1 \circ g^r = (h'_1)^{-1}$ . So  $h'_1, g'$  generate a group isomorphic to  $F_r \rtimes \mathbf{Z}_{2r}$ . Argue as in the proof of Theorem 4.1 that  $h'_1$  may be chosen such that

$$\bigcup F_r \rtimes \mathbf{Z}_{2r} (B^4 - \dot{a}'_1 - \dots - \dot{a}'_r - \dot{b}'_r) = \Lambda_\psi.$$

Thus we have the desired extension  $\psi': (F_r \rtimes \mathbf{Z}_{2r}) \times B^4 \rightarrow B^4$ . Doubling  $B^4$  and extending the action in the natural way gives the admissible action  $\psi''$ . q.e.d.

Notice that  $\psi'$  has an extension  $(F_r \rtimes \mathbf{Z}_{2r}) \times \mathbf{Z}_2 \times S^4 \rightarrow S^4$ , where  $\mathbf{Z}_2$  acts by reflection in  $S^3$ . A similar statement is true of  $\phi''$ .

In the earlier paper [10] only admissible actions of free groups were considered, and an identification of the extension problem with the full topological surgery conjecture was obtained. We point out here that when the group acting is even slightly more complicated, an extension from  $S^3$  to  $S^4$  does not always exist, even topologically.

To illustrate, let  $G = F_3 \rtimes \mathbf{Z}_3$ , where  $\mathbf{Z}_3$  acts by cyclic permutation of a basis of  $F_3$ . We will obtain an action  $G \times S^3 \rightarrow S^3$  by adding a 3-fold symmetry to the example described in [10]. Briefly, form a six component link by replacing each component of the Borromean rings by two parallel solid tori. Construct the action of  $F_3 \approx \langle h_1, h_2, h_3 \rangle$  by letting  $h_i$  map the interior of the  $i$ th Borromean ring component to the exterior of its parallel copy. Now the 3-fold symmetry of the link allows the action to extend to all of  $G$ . A calculation which may be made using the methods of the Kirby calculus gives the smooth orbifold description of  $\Omega/G = N$  of Figure 4.1. Note that, as a manifold,  $N \approx S^1 \times S^2$ .

Suppose  $\omega$  had an extension  $\bar{\omega}: G \times B^4 \rightarrow B^4$  which is admissible. We will obtain a contradiction. Using Smith theory, one may determine that the underlying smooth manifold of  $\bar{\omega}: /G \approx M$  has the  $\mathbf{Z}_2$ -homology of  $S^1 \times B^3$  and that the only nontrivial stratum is a  $\mathbf{Z}_3$  stratum homeomorphic to a 2-disk (with boundary equal to the  $\mathbf{Z}_3$  stratum of  $N$ ).

The link of Figure 4.1 is symmetric, so regard the longer component as the boundary of the  $\mathbf{Z}_3$ -stratum of  $\bar{\omega}$  and the shorter component as indicating a 1-handle. It is clear that the longer component also bounds in immersed disk  $D$  with one transverse double point. Taking  $D$  near the boundary of  $M$  we may suppose  $D$  intersects the  $\mathbf{Z}_3$ -stratum only in  $\partial D$ . Thus we have constructed a 2-sphere  $S^2$  with one transverse double point representing the

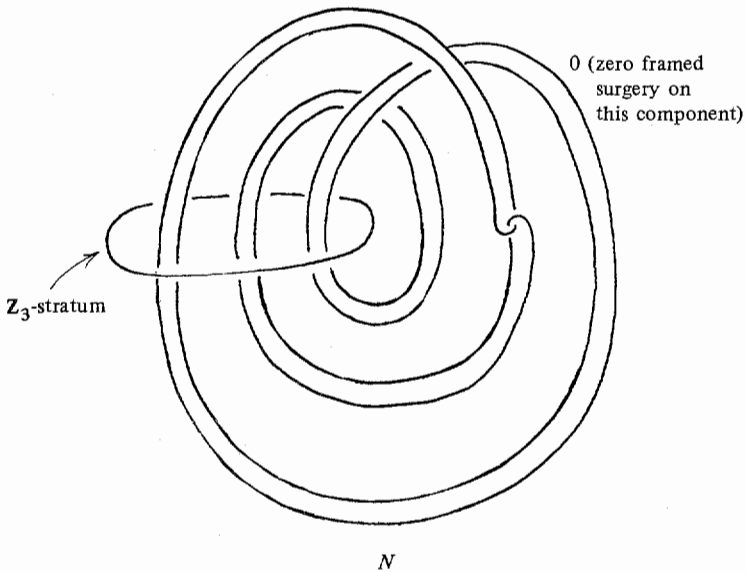

FIGURE 4.1

generator of  $H_1(M; \mathbf{Z}_2)$ . Let  $\tilde{M}$  be a 2-fold covering determined by the generator of  $H_1(M; \mathbf{Z}_2)$ . By the Gysin sequence  $\tilde{M}$ , like  $M$ , is a  $\mathbf{Z}_2$ -homology  $S^1 \times B^3$ . Taking a 2-fold covering  $\tilde{\tilde{M}}$  of  $\tilde{M}$  gives another  $\mathbf{Z}_2$ -homology  $S^1 \times B^3$ . But two adjacent lifts of  $S^2$  in  $\tilde{\tilde{M}}$  will have intersection number equal to one—contradicting that  $H_2(\tilde{\tilde{M}}; \mathbf{Z}_2) \approx 0$ . q.e.d.

This argument, when combined with [10], shows that  $\pm$  Whitehead double of the Borromean rings is not topologically slice in a way that respects the  $\mathbf{Z}_3$  symmetry of that link.

## 5. Higher dimensional examples

In this section we give two constructions of admissible actions on  $S^n$ . Our first construction involves spinning an admissible action on  $S^3$ . This gives examples for  $n \geq 4$ . The second construction is a homological copy of the Schottky action. This gives examples for  $n \geq 5$ . We also show concretely that in both cases these actions have extensions to Schottky actions on the next higher dimensional sphere (this also follows from [10]). We do not investigate the geometry of these actions but these explicit descriptions would serve as a starting point.

To describe the first construction we need another example in  $S^3$ . Let  $a_1, a_2, b_1, b_2$  be pairwise disjoint, unknotted solid tori in  $S^3$ . They are pictured in Figure 5.1. Let  $j_1, j_2: S^3 \rightarrow S^3$  be orientation preserving homeomorphisms, such that  $j_i(S^3 - \dot{a}_i) = b_i, i = 1, 2$ . The images of  $j_1$  and  $j_1^{-1}$  are shown in Figure 5.2 (the images of  $j_2$  and  $j_2^{-1}$  are similar). The group generated by  $j_1$  and  $j_2$  is the free group of rank 2, denoted  $F_2$ . Let  $\mathcal{D} = S^3 - \dot{a}_1 - \dot{a}_2 - \dot{b}_1 - \dot{b}_2$  and  $U = \cup F_2(\mathcal{D})$ . The same argument of §2 shows that we may also choose  $j_1$  and  $j_2$  such that  $S^3 - U$  is a Cantor set. Therefore, the action  $F_2 \times S^3 \rightarrow S^3$  is admissible.

We now use the above example and spinning to get higher dimensional examples. Let  $B^3$  be a 3-ball in  $S^3$  as pictured in Figure 5.1. Identify  $S^n = \partial(B^3 \times B^{n-2})$ . Then (to avoid the proliferation of notation) let  $(a_i \times B^{n-2}) \cap S^n$  be denoted by  $a_i$ , and let a regular neighborhood of  $b_i \times p$  be denoted by  $b_i, i = 1, 2$ , where  $p$  is any point in  $\partial B^{n-2}$ .

Clearly  $a_1 \approx a_2 \approx S^{n-2} \times B^2$  and  $b_1 \approx b_2 \approx S^1 \times B^{n-1}$ . The linking is like that of the 3-dimensional analogue, so Figures 5.1 and 5.2 now serve as schematics.

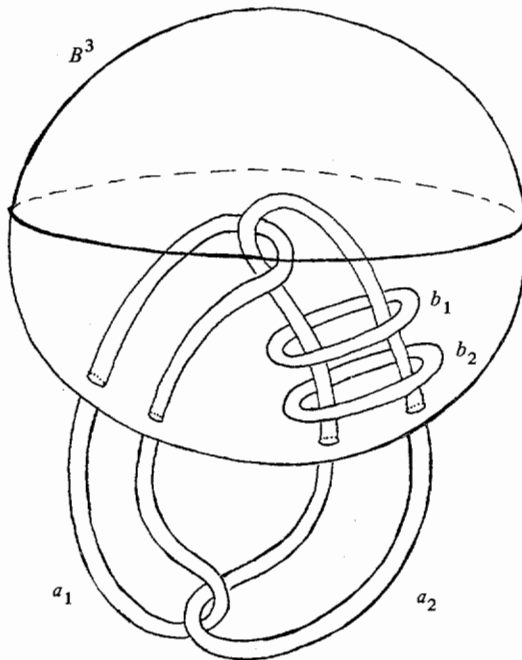

FIGURE 5.1

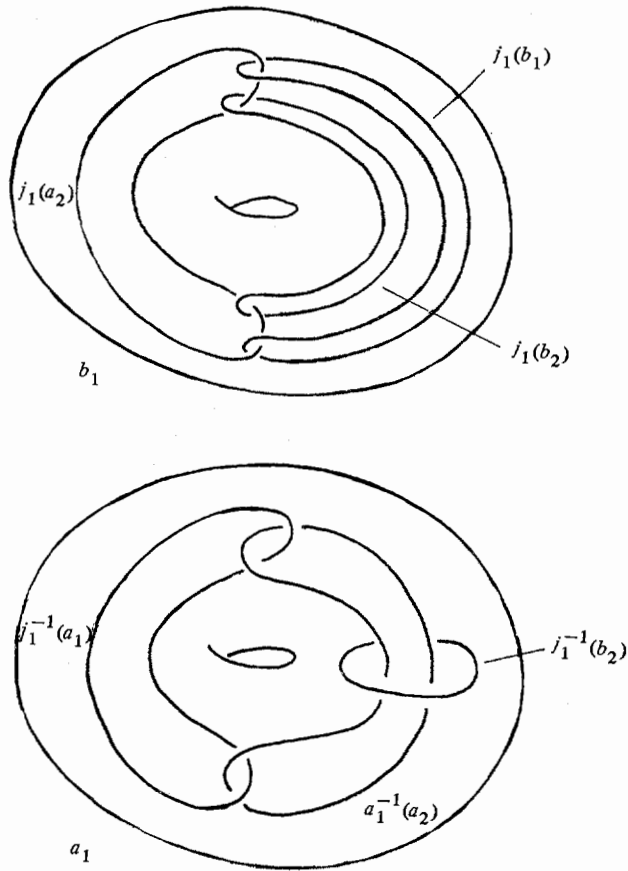

FIGURE 5.2

The reader may now anticipate the action. Let  $j_1, j_2: S^n \rightarrow S^n$  be orientation preserving homeomorphisms such that  $j_1(S^n - \dot{a}_1) = b_1$  and  $j_2(S^n - \dot{a}_2) = b_2$ . The group generated by  $j_1, j_2$  is the free group of rank 2, denoted  $F_2$ . Let  $\mathcal{D} = S^n - \dot{a}_1 - \dot{b}_1 - \dot{a}_2 - \dot{b}_2$  and  $U = \cup F_2(\mathcal{D})$ . To show  $j_1, j_2$  may be chosen such that  $S^n - U$  is a Cantor set requires understanding of both the Bing Decomposition and the Spun Bing Decomposition. The Bing Decomposition is shrinkable [3], [4]. [Recall that in §2 the position of certain subsets (there solid tori) were not defined except upto isotopy. In our paper one may translate “shrinkable” to mean that the appropriate nested collection may be

arranged (by isotopy) to have diameters approach zero.] The Spun Bing Decomposition was first shrunk by Edwards [7]. The implication is that  $U$  may be isotoped in  $S^n$  so that  $S^n - U$  is a Cantor set. Thus assume  $j_1$  and  $j_2$  are chosen such that  $S^n - U$  is a Cantor set.

Let  $\zeta: F_2 \times S^n \rightarrow S^n$  denote the action.

**5.1. Theorem.** *The action  $\zeta: F_2 \times S^n \rightarrow S^n$ ,  $4 \leq n$ , is admissible and distinct from the Schottky action. Furthermore, there is an invariant, topologically flat embedding  $S^n \hookrightarrow S^{n+1}$  and Schottky action  $\omega: F_2 \times S^{n+1} \rightarrow S^{n+1}$ , such that  $\zeta = \omega|_{F_2 \times S^n}$ .*

*Proof.* The action is clearly admissible and it is distinguished from the Schottky action by the wildness of  $\Lambda_\zeta$ : the complement of  $\Lambda_\zeta$  is not simply connected.

The rest of the proof is as in 4.1, except for one modification. In extending the action to  $B^{n+1}$  one attaches 2-handle along  $b_1$  and  $b_2$ . The rest of the argument is forced.

**Note.** If in attempting to prove the above one attaches an  $(n - 1)$ -handle along  $a_1$  and  $a_2$ , then the argument is impossible to complete.

We now give our second higher dimensional construction. It gives examples of admissible actions on  $S^n$ ,  $n \geq 5$ , distinct from Schottky actions. The example is, however, a homological copy of the Schottky action. No comparable examples has been found for  $n = 4$ . Like the other examples we show that it is the cross section of a Schottky action on the next higher dimensional sphere.

Let  $X$  be the piecewise-linear, 2-dimensional spine of a nonsimply connected, homology 3-ball. For  $n \geq 5$ , let  $X \hookrightarrow \mathbf{R}^{n+1}$  be a PL embedding with regular neighborhood  $N(X)$ . Notice that  $\pi_1(\partial N(X)) \approx \pi_1(X)$ . Take three isomorphic copies  $X_1, X_2, X_3$  of  $X$  and let  $X_1, X_2, X_3 \rightarrow \partial N(X)$  be disjoint, PL embeddings with disjoint regular neighborhoods  $N(X_1), N(X_2), N(X_3) \subset \partial N(X)$  respectively.

Define  $Q = \partial N(X) - \cup \dot{N}(X_i)$ , and label its boundary components  $A_1, A_2, A_3$ . Choose a disjoint copy  $(R, B_1, B_2, B_3) \approx (Q, A_1, A_2, A_3)$ . Finally define  $\mathcal{D} = Q \sqcup R/A_3 = B_3$ . Orient  $\mathcal{D}$  and take the induced orientation on  $\partial \mathcal{D}$ . Then  $\mathcal{D}$  has the following nice properties:

(1)  $\partial \mathcal{D} \approx A_1 \sqcup A_2 \sqcup -A_1 \sqcup -A_2$ , where  $-A_i$  denotes  $A_i$  with opposite orientation, and

(2)  $\pi_1(\mathcal{D}) \approx \pi_1(X) \approx 1$ , and the inclusion of each boundary component of  $\mathcal{D}$  into  $\mathcal{D}$  induces an isomorphism on  $\pi_1$ .

It is well known that  $A_1$  bounds a contractible  $n$ -manifold; let  $a_1, b_1$  be two copies of such a contractible manifold. Similarly choose  $a_2, b_2$  for  $A_2$ . Let  $Y$

be the quotient

$$\frac{\mathcal{D} \cup a_1 \cup b_1 \cup a_2 \cup b_2}{\partial a_i = A_i; \partial b_i = -B_i \ (i = 1, 2)}.$$

It is easy to see that  $\pi_1(Y) = 1$ ; using the high dimension Poincaré Theorem fix a homeomorphism  $Y \approx S^n$ . Also identify  $S^n \approx \partial B^{n+1}$ .

The  $(n + 1)$ -ball provides an  $h$ -cobordism  $(B^{n+1}, a_i, S^n - \hat{a}_i)$ . By the  $h$ -cobordism theorem  $(B^{n+1}, a_i) \approx (a_i \times [0, 1], a_i \times \{0\})$ . Hence  $(S^n, a_i) \approx (S^n, S^n - a_i)$ . By construction  $(S^n, a_i) \approx (S^n, b_i)$ . Hence  $(S^n, S^n - \hat{a}_i) \approx (S^n, b_i)$  by orientation preserving homeomorphism. Let  $j_i: S^n \rightarrow S^n$  be an orientation-preserving homeomorphism such that  $j_i(S^n - \hat{a}_i) = b_i, i = 1, 2$ . Then  $j_1, j_2$  generate the free group of rank 2, denoted  $F_2$ . Let  $\mathcal{D} = S^n - \hat{a}_1 - \hat{b}_1 - \hat{a}_2 - \hat{b}_2$  and  $U = \cup F_2(\mathcal{D})$ .

Let  $\mathcal{G}$  be the decomposition whose elements are points of  $U$  and components of  $S^n - U$ . Since  $a_1, b_1, a_2, b_2$  are contractible, the projection  $S^n \rightarrow S^n/\mathcal{G}$  is cell-like. It is routine to check that  $S^n/\mathcal{G}$  is a generalized  $n$ -manifold and satisfies the Disjoint Disks Property (a similar decomposition was constructed by R. Daverman; see [6] for details of the verification of the above properties). By theorems of J. Cannon [5] or R. Edwards [8],  $S^n/\mathcal{G} \approx S^n$ . Actually the implication is stronger. It says that  $U$  may be isotoped such that the complement of  $S^n - U$  is a Cantor set. Thus suppose the  $j_i$ 's were chosen to determine such a  $U$ .

Let  $\theta: F_2 \times S^n \rightarrow S^n$  be the action. It is clearly admissible.

**5.2. Theorem.** *The action  $\theta: F_2 \times S^n \rightarrow S^n, n \geq 5$ , is admissible and distinct from the Schottky action. Furthermore, there is an invariant, topologically flat embedding  $S^n \hookrightarrow S^{n+1}$  and Schottky action  $\omega: F_2 \times S^{n+1} \rightarrow S^{n+1}$  such that  $\omega|_{F_2 \times S^n} = \theta$ .*

*Proof.* Property (2) of  $\mathcal{D}$  implies that  $\pi_1(\Omega_\theta) \approx \pi_1(X) \neq 1$ . Thus  $\Lambda_\theta$  is a wild Cantor set and  $\theta$  is not conjugate to a Schottky action.

To prove the second part we first extend the action to  $B^{n+1}$ . Recall that  $B^{n+1}$  is an  $h$ -cobordism between  $a_i$  and  $S^n - \hat{a}_i, i = 1, 2$ . There are disjoint sets  $a'_1, a'_2, b'_1, b'_2 \subset B^{n+1}$ , such that

$$(B^{n+1}, a'_i, a_i) \approx (a_i \times [0, 2], a_i \times [0, 1], a_i \times [0, 1] \cap \partial(a_i \times [0, 2])),$$

$$(B^{n+1}, b'_i, b_i) \approx (b_i \times [0, 2], b_i \times [0, 1], b_i \times [0, 1] \cap \partial(b_i \times [0, 2])),$$

$$i = 1, 2.$$

Let  $j'_1, j'_2: B^{n+1} \rightarrow B^{n+1}$  be orientation preserving homeomorphisms, such that  $j'_i(B^{n+1} - \hat{a}'_i) = b'_i$  and  $j'_i|_{S^n} = j_i, i = 1, 2$ . Then  $j'_1$  and  $j'_2$  generate the free group of rank 2, denoted  $F_2$ . Let  $\mathcal{D}' = B^{n+1} - \hat{a}'_1 - \hat{a}'_2 - \hat{b}'_1 - \hat{b}'_2$  and

$U' = \cup F_2(\mathcal{D}')$ . Then we may also assume that  $j'_1, j'_2$  were chosen such that  $B^{n+1} - U' = \Lambda_\theta$  (because  $a'_1, a'_2, b'_1, b'_2$  are products we may choose  $j'_1, j'_2$  such that the images of  $a'_1, a'_2, b'_1, b'_2$  under the action converge to  $\Lambda_\theta$ ).

Finally, let  $S^{n+1}$  be the double of  $B^{n+1}$  along  $S^n$ , and let  $\theta'': F_2 \times S^{n+1} \rightarrow S^{n+1}$  be the obvious extension of the action of  $j'_1$  and  $j'_2$ . Since  $a'_i \approx a_i \times [0, 1]$  and  $a_i$  is contractible,  $a'_i \approx B^{n+1}$ ,  $i = 1, 2$ . Also the double of  $a'_i$  along  $a_i$  is homeomorphic to  $B^{n+1}$ . Hence  $\theta''$  is defined by balls which by construction are topologically flat. By Theorem 1.2,  $\theta''$  is conjugate to a Schottky action  $\omega$ . q.e.d.

Notice that  $\theta''$  has an extension  $(F_2 \times \mathbf{Z}_2) \times S^{n+1} \rightarrow S^{n+1}$ , where the  $\mathbf{Z}_2$  acts by reflection in  $S^n$ . A corresponding comment is true for the extension in Theorem 5.1.

## References

- [1] M. Bestvina, to appear.
- [2] M. Bestvina & D. Cooper, *A wild Cantor set as the limit set of a conformal group action on  $S^3$* , to appear.
- [3] R. H. Bing, *A homeomorphism between the 3-sphere and the sum of two solid horned spheres*, Ann. of Math. **56** (1952) 354–362.
- [4] ———, *Shrinking without Lengthening*, preprint.
- [5] J. Cannon, *Shrinking cell-like decompositions of manifolds. Codimension three*, Ann. of Math. **110** (1979) 83–112.
- [6] R. J. Daverman, *Embedding phenomena based upon decomposition theory: Wild Cantor sets satisfying strong homogeneity properties*, Proc. Amer. Math. Soc. **75** (1979) 177–182.
- [7] R. D. Edwards, *Suspensions of homology spheres*, unpublished.
- [8] ———, *Approximating certain cell-like maps by homeomorphisms*, unpublished.
- [9] M. H. Freedman, *The disk theorem for four dimensional manifolds*, Proc. Internat. Congr. Math. (Warsaw), 1982, 647–663.
- [10] ———, *A geometric reformulation of 4-dimensional surgery*, Topology Appl., to appear.
- [11] F. W. Gehring & B. P. Palka, *Quasiconformally homogeneous domains*, J. Analyse Math. **30** (1976) 172–199.
- [12] C. H. Giffen, *The generalized Smith conjecture*, Amer. J. Math. **88** (1966) 187–198.
- [13] R. Kirby, *Stable homeomorphisms and the annulus conjecture*, Ann. of Math. **89** (1969) 575–582.
- [14] I. Kra, *Automorphic forms and Klienian groups*, Benjamin, Reading, MA, 1972.
- [15] Gaven Martin, *Discrete quasiconformal groups that are not the quasiconformal conjugates of Möbius groups*, Ann. Acad. Sci. Fenn. Ser. A. I. Math. **11** (1986).
- [16] E. Moise, *Affine structures in 3-manifolds. I–V*, Ann. of Math. **54** (1951) 506–553; **55** (1952) 172–176, 203–214, 215–222; **56** (1952) 96–114.
- [17] F. Quinn, *Ends of maps. III. Dimensions 4 and 5*, J. Differential Geometry **17** (1982) 503–521.
- [18] T. Radó, *Über den Begriff der Riemannschen Fläche*, Acta Univ. Szeged **2** (1924–26) 101–121.
- [19] R. Skora, *Cantor sets in  $S^3$  with simply connected complements*, Topology Appl., to appear.

- [20] D. Sullivan, *On the ergodic theory at infinity of an arbitrary discrete group of hyperbolic motions*, Riemann Surfaces and Related Topics (Proc. of the 1978 Stony Brook Conf., I. Kra and B. Maskit, eds.), Annals of Math. Studies, No. 97, Princeton University Press, Princeton, NJ, 1981, 564–596.
- [21] P. Tukia, *On two-dimensional quasiconformal groups*, Ann. Acad. Sci. Fenn. Ser. A. I. Math. **5** (1980) 73–78.
- [22] ———, *A quasiconformal group not isomorphic to a Möbius group*, Ann. Acad. Sci. Fenn. Ser. A. I. Math. **6** (1981) 149–160.
- [23] Jussi Väisälä, *Lectures on  $n$ -dimensional quasiconformal mappings*, Lecture Notes in Math., vol. 229, Springer, Berlin, 1971.

UNIVERSITY OF CALIFORNIA, SAN DIEGO  
INDIANA UNIVERSITY, BLOOMINGTON